



Technical Data / Fiche Technique / Technische Daten / Datos Técnicos

Spill Pallets ■ Palettes de rétention ■ Auffangwannen ■ Palets para derrames

SJ-100-001 / SJ-100-002



SJ-100-001



SJ-100-002



















Features/Caractéristiques/Merkmale/Características

Spill pallet for 2 drums • Removable platform • For static spill containment • Remove drums before fork lifting • Compatible with most forklifts and pallet trucks • Made from PE - 100% recyclable.

Palette de rétention pour stocker 2 fûts • Caillebotis amovible • Usage statique uniquement: ne peut pas être utilisée pour transporter les matières dangereuses (fûts) • Ceux-ci doivent être retirés avant toute manipulation par chariot élévateur ou transpalette • Manipulable avec la plupart des chariots élévateurs et transpalettes • 100% PE • 100% recyclable.

Auffangwanne für 2 Fässer • abnehmbare Lochplatte • für den stationären Gebrauch • vor Transport mit Stapler Fässer entfernen • für die meisten Stapler/Handhubwagen geeignet • aus PE - 100%ig recycelbar.

Palet de derrames para 2 bidones • Cubierta desmontable • Palet fijo para derrames • Quite los bidones antes de utilizar una carretilla elevadora • Para usar con la mayoría de carretillas elevadoras y transpaletas • Fabricado en polietileno (PE) 100% reciclable.

	 mm	 mm	 mm	 kg		 mm				A/B mm	C/D mm	 kg
SJ-100-001	440	1300	750	20.5		630 x 1180 x 55				190 / 815	-	650
SJ-100-002												

Jonesco (Preston) Ltd.
Pittman Way
Fulwood
Preston PR2 9ZD
England
Tel: +44 (0) 1772 704488
Fax: +44 (0) 1772 702209

Jonesco S.A.R.L.
SECLIN UNEXPO
1524 Avenue de l'Épinette
59113 Seclin
France
Tel: +33 (0) 3 20 32 1111
Fax: +33 (0) 3 20 90 6210
SARL au capital de 8,000 euros





Technical Data / Fiche Technique / Technische Daten / Datos Técnicos

Spill Pallets ■ Palettes de rétention ■ Auffangwannen ■ Palets para derrames

SJ-100-001 / SJ-100-002

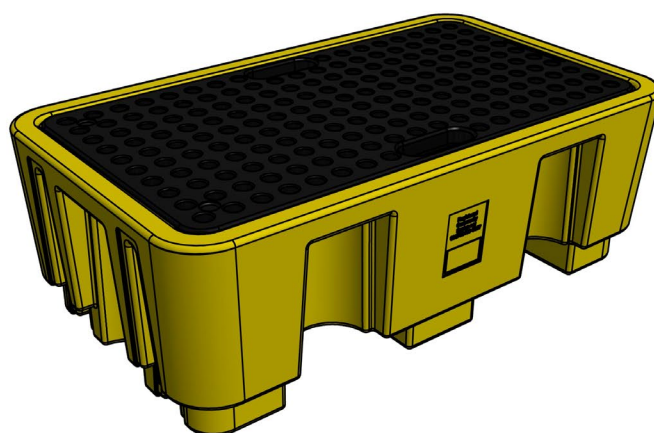
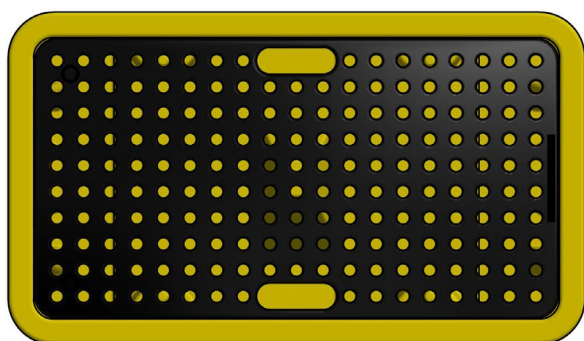
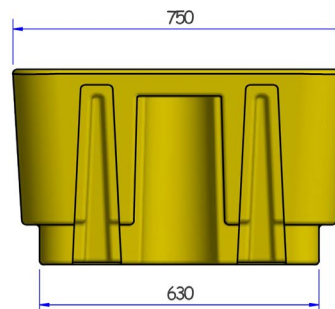
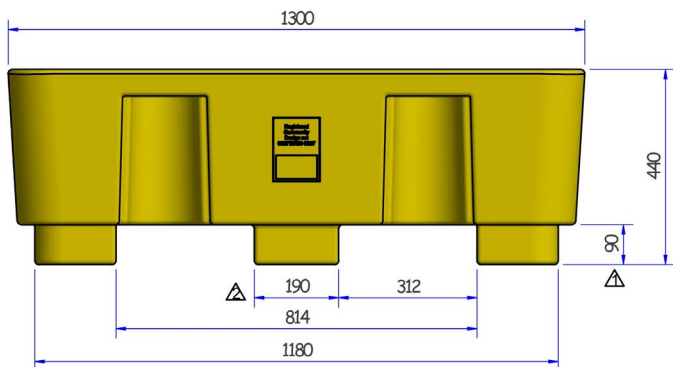

SJ-100-001/002 - 5 units per pallet / 5 pièces par palette / 5 Teile pro Palette / 5 piezas por palé

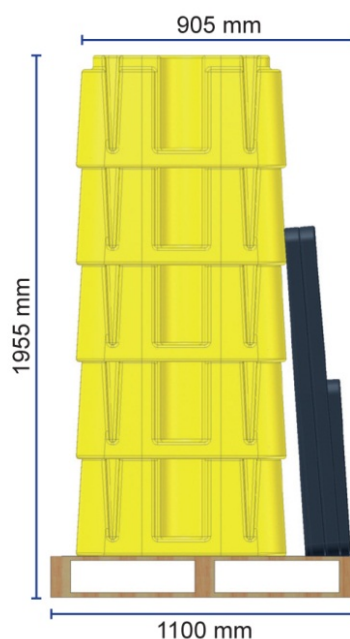
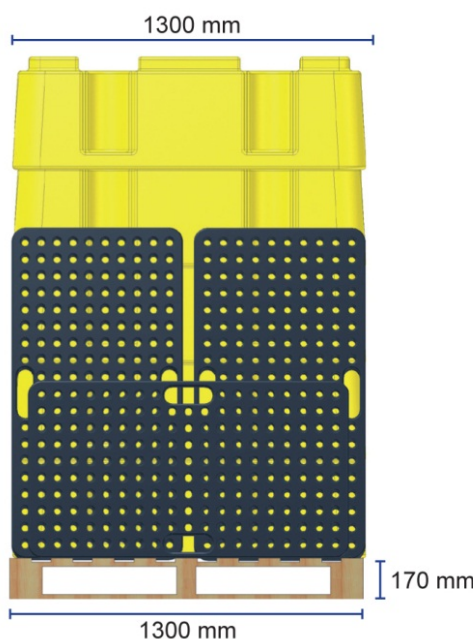

Jonesco (Preston) Ltd.
 Pittman Way
 Fulwood
 Preston PR2 9ZD
 England
 Tel: +44 (0) 1772 704488
 Fax: +44 (0) 1772 702209

Jonesco S.A.R.L.
 SECLIN UNEXPO
 1524 Avenue de l'Épinette
 59113 Seclin
 France
 Tel: +33 (0) 3 20 32 1111
 Fax: +33 (0) 3 20 90 6210
 SARL au capital de 8,000 euros



www.jonesco-plastics.com